

**HO Lost Wax Brass**

**CARY**

Cary a Division of Bowser Mfg  
PO Box 322  
Montoursville PA 17754

**A**



#13-197  
Air Horn

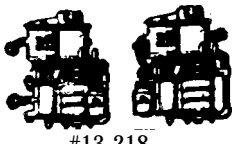

#13-218  
Air pumps  
Smokebox Mounted  
Right & Left

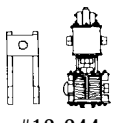

#13-244  
Air Pump  
W/Bracket  
9 1/2" Single phase

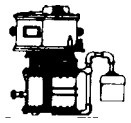

#13-167  
Air Pump  
Westinghouse

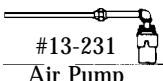

#13-231  
Air Pump  
Strainer

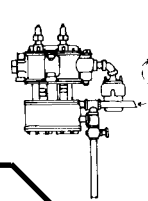

#13-254  
Air Pump w/  
Governor  
New York

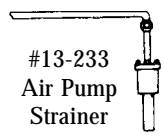

#13-233  
Air Pump  
Strainer

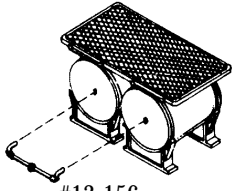

#13-156  
Air Tank PRR I-1

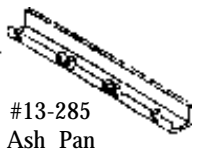

#13-285  
Ash Pan

**B**



#13-144  
1890 Era  
Bell



#13-154  
Front  
Mount  
Bell



#13-185  
Angled,  
Front Mount  
Bell



#13-176  
w/ Kick  
Back Air  
Ringer  
Bell



#13-145  
1910  
Lima  
Bell

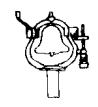

#13-195  
Modern  
Flush  
Mount

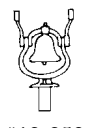

#13-250  
PRR  
Old type  
Bell

**B**



#13-246  
Front Mount

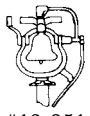

#13-251  
Anti-Rotation  
w/ Air Line



#13-196  
Rigid Steam or  
Diesel



#13-190  
Air Ringer  
Side Mount



#13-186  
Straight  
Front Mount



#13-249  
Front Mount  
Angle Bracket  
w/Ball Top



#13-134  
Front Mount

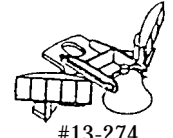

#13-274  
Bell &  
Number Boards

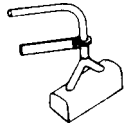

#13-224  
Blowdown  
Right & Left

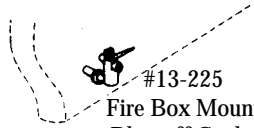

#13-225  
Fire Box Mount  
Blowoff Cocks  
Right & Left



#13-160  
Okadee Type1  
Blowoff Cocks

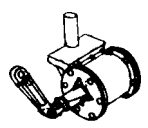

#13-189  
Brake Cylinder  
Tender, Large



#13-136  
Brake Cylinder  
Tender Set

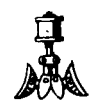

#13-116  
Brake Cylinder Loco  
used on 4-4-0

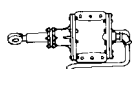

#13-257  
Brake Cylinder  
w/ Pipe, Large

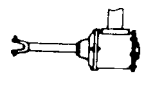

#13-175  
Brake Cylinder  
Loco

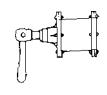

#13-258  
Brake Cylinder  
Loco  
Right & Left



#13-232  
Brake Cylinder  
Loco & Tender  
Right & Left

**C**

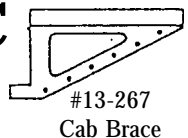

#13-267  
Cab Brace



#13-265  
Prime Cylinder  
Cocks (6 pc)



#13-255  
Lagging Clamps  
(8 pcs)

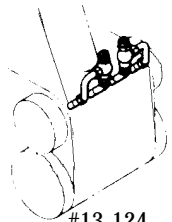

#13-124  
Cylinder Cocks  
Viloco (4 pcs)

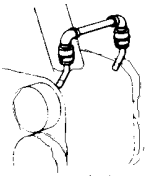

#13-121  
Prime Cylinder  
Cocks (2 pc)

**D**



#13-266  
Dome Cover  
Oval Sand (4 pc)



#13-277  
Dome Cover  
Round Sand  
(4 pc)

**F**



#13-270  
Foam Spreader

**G**



#13-219  
Pump Governor  
w/ Lagged Pipe & Valve



#13-221  
Pump Governor  
w/ Lagged Pipe

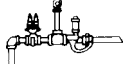

#13-220  
Pump Governor  
w/ Relief Valve



#13-161  
Generator  
w/ Muffled Stack



#13-126  
Generator  
On Platform w/  
Electric Lines

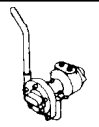

#13-141  
Generator  
Early Pyle

## H

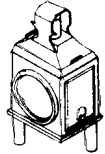

#13-142  
Oil Lamp  
1890 era  
Headlight

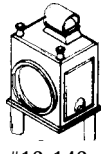

#13-143  
Oil Lamp  
Rogers  
1890 era  
Headlight

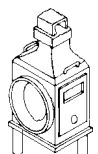

#13-247  
PRR - Old  
Box Type  
Headlight



#13-135  
ARC Lamp  
Lima  
Headlight



#13-177  
Wing Board  
Headlight

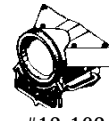

#13-162  
Union Pacific  
w/bracket  
Headlight

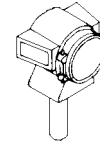

#13-248  
Harriman  
w/ Wing Boards  
Headlight



#13-108  
Harriman  
Headlight



#13-157  
CB & O  
coo-coo clock  
Headlight



#13-194  
Mars Light  
Steam Loco  
Headlight

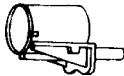

#13-193  
Mars Light  
Large  
Steam//Diesel



#13-275  
Headlight

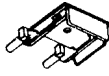

#13-151  
Headlight Bracket

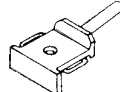

#13-213  
Headlight Bracket  
Flat Front  
Mount



#13-128  
Headlight Bracket  
Typical  
SP & UP



#13-153  
Handrail Stanchion  
Modern (14 pcs)



#13-117 - Dozen  
#13-118 - 50 pk.  
Handrail Stanchion  
Turned Brass

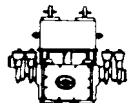

#13-163  
Feedwater  
Heater Pump  
HD Elesco



#13-191  
Feedwater  
Heater  
Pump

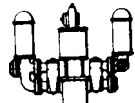

#13-129  
Feedwater  
Heater  
Early Elesco

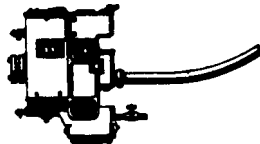

#13-101  
Feedwater Heater  
Worthington BL

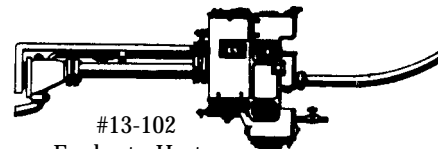

#13-102  
Feedwater Heater  
Pennys I-1, Worthington BL

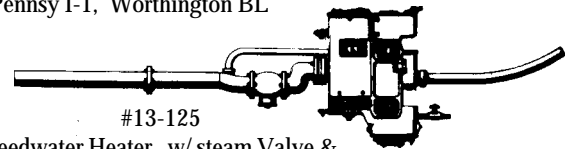

#13-125  
Feedwater Heater, w/ steam Valve &  
Line, Worthington BL

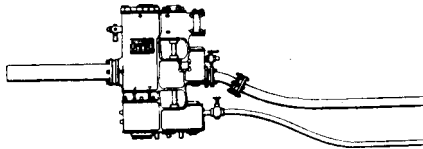

#13-150  
Feedwater Heater, Flat Bottom  
Worthington BL

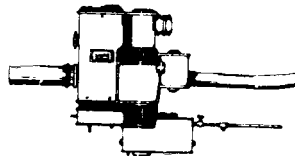

#13-168  
Feedwater Heater  
Large, Worthington BL

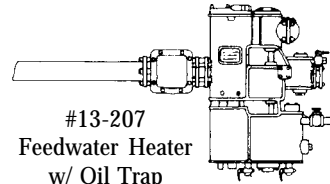

#13-207  
Feedwater Heater  
w/ Oil Trap  
Worthington BL

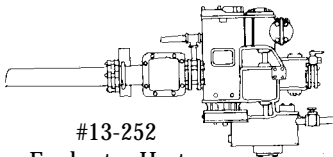

#13-252  
Feedwater Heater  
Oil Trap Step Bottom  
Worthington

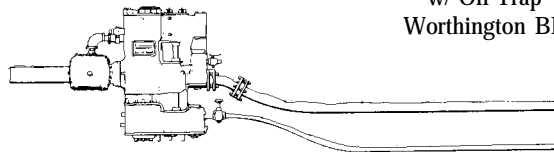

#13-253  
Feedwater Heater  
w/ Oil Trap Flat Step

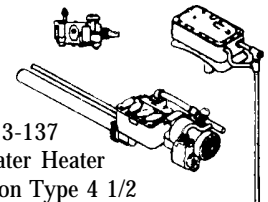

#13-137  
Feedwater Heater  
Worthington Type 4 1/2  
PRR M1a & K-5 Locos

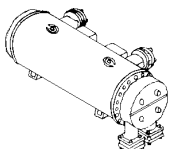

#13-235  
L.G. Elesco  
Vertical Pipes

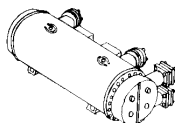

#13-234  
L.G. Elesco Heater  
Horizontal Pipes

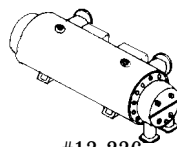

#13-236  
Standard  
Elesco Heater

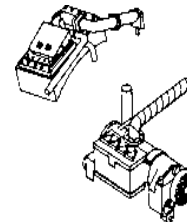

#13-245  
Feedwater Heater  
Worthington  
Pilot Mount

**I**

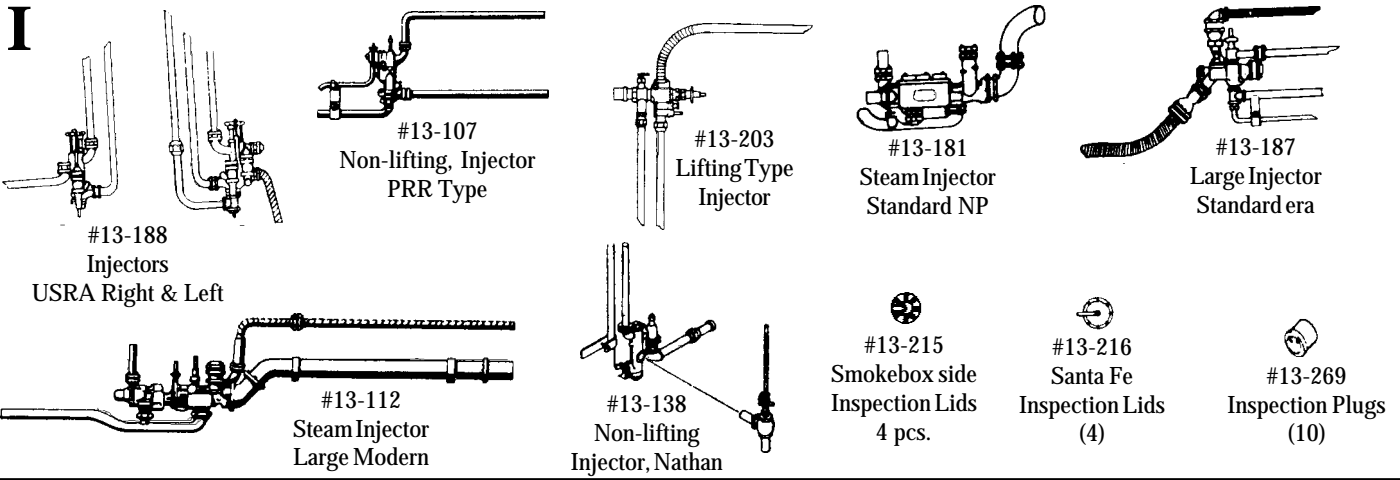

#13-188 Injectors USRA Right & Left

#13-107 Non-lifting, Injector PRR Type

#13-203 Lifting Type Injector

#13-181 Steam Injector Standard NP

#13-187 Large Injector Standard era

#13-112 Steam Injector Large Modern

#13-138 Non-lifting Injector, Nathan

#13-215 Smokebox side Inspection Lids 4 pcs.

#13-216 Santa Fe Inspection Lids (4)

#13-269 Inspection Plugs (10)

**J**

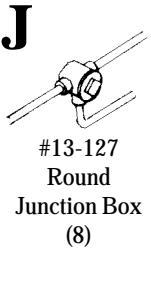

#13-127 Round Junction Box (8)

**L**

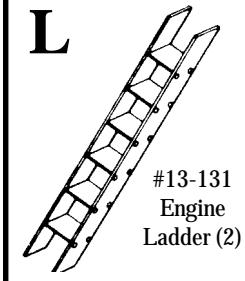

#13-131 Engine Ladder (2)

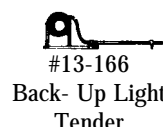

#13-166 Back- Up Light Tender

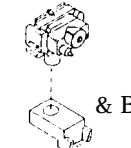

#13-283 Lubricator & Bracket set of 4

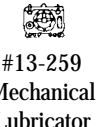

#13-259 Mechanical Lubricator



#13-159 Classification Light Modern PRR

**M**

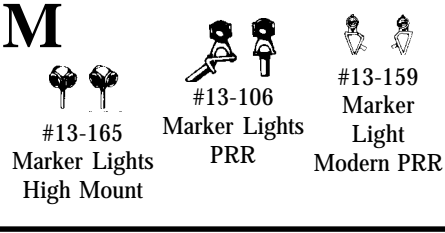

#13-165 Marker Lights High Mount

#13-106 Marker Lights PRR

#13-159 Marker Light Modern PRR

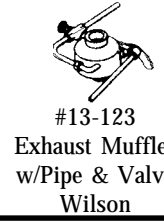

#13-123 Exhaust Muffler w/Pipe & Valve Wilson

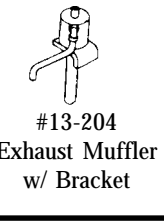

#13-204 Exhaust Muffler w/ Bracket



#13-130 Blow Off Muffler

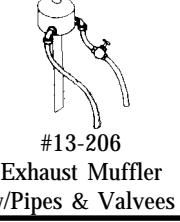

#13-206 Exhaust Muffler w/Pipes & Valves

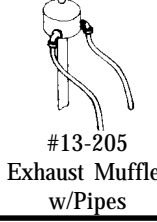

#13-205 Exhaust Muffler w/Pipes

**N**

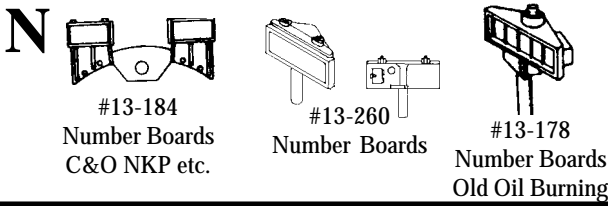

#13-184 Number Boards C&O NKP etc.

#13-260 Number Boards

#13-178 Number Boards Old Oil Burning

**O**

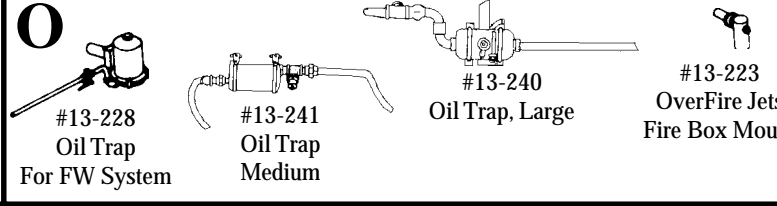

#13-228 Oil Trap For FW System

#13-241 Oil Trap Medium

#13-240 Oil Trap, Large

#13-223 OverFire Jets Fire Box Mount

**P**

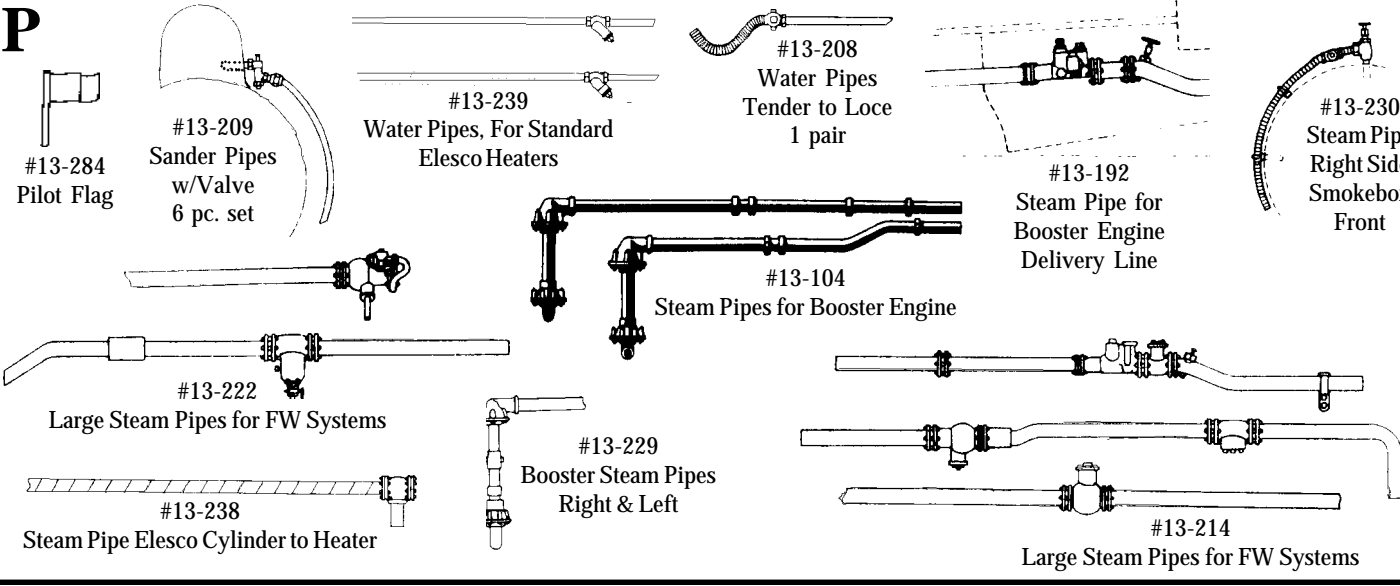

#13-284 Pilot Flag

#13-209 Sander Pipes w/Valve 6 pc. set

#13-239 Water Pipes, For Standard Elesco Heaters

#13-208 Water Pipes Tender to Loce 1 pair

#13-192 Steam Pipe for Booster Engine Delivery Line

#13-230 Steam Pipe Right Side Smokebox Front

#13-104 Steam Pipes for Booster Engine

#13-222 Large Steam Pipes for FW Systems

#13-229 Booster Steam Pipes Right & Left

#13-238 Steam Pipe Elesco Cylinder to Heater

#13-214 Large Steam Pipes for FW Systems

**HO Lost Wax Brass**

**CARY**

Cary a Division of Bowser Mfg  
PO Box 322  
Montoursville PA 17754

**P**

#13-227  
Pipes & Valves Smokebox Front Left Side

#13-237  
Water Pipes w/Traps for Large Elesco Heaters

#13-158  
Pipe Hangers Strap Type

#13-170  
Pipe Hangers U-Bolt Type

#13-133  
Power Reverse

#13-110  
Alco Type "T"

#13-278  
Power Reverse

#13-242  
Lagged Pipe  
5" dia. 2-3" pcs.

#13-243  
Lagged Pipe  
3" dia. 2-4" pcs

**R**

#13-182  
Rerailed Frog in Bracket Under Hung

#13-183  
Rerailed Frog in Bracket Side Hung

**S**

#13-273  
UP Shield

#13-119  
4'1" dia. (9/16") w/ Number Plate

#13-171  
5' dia. (11/16) w/ Number Plate

#13-105  
8" dia. (1 7/64") w/ Number Plate

#13-114  
7'5" dia. (1 1/32") w/ Number Plate

#13-256  
Tender Steps

#13-268  
Walk Steps

**V**

#13-210  
Sander Valve Single Pipe

#13-211  
Sander Valve 2 Pipe

#13-113  
Sander Valves PRR Style

**T**

#13-173  
Steam Turret USRA Style

#13-281  
Turret PRR Wilson

#13-279  
Trailing truck Brace

#13-264  
Cylinder Relief Valves, Top Mount

#13-212  
Cylinder Relief Valve Top Mount

#13-263  
Cylinder Relief Valves, Top Mount

#13-132  
Boiler Check Valves Nathan Heavy

**V**

#13-172  
Pop Valve & Whistle set

#13-282  
Snifter Valve set of 4 pcs.

#13-103  
Pop Valves & Whistle PRR Style

#13-109  
Starter Valve Standard

#13-262  
Starter Valve

#13-139  
Starter Valve Chicago Std. "T" Lever

#13-179  
Starter Valve USRA Style

#13-122  
Blow Off Valves Wilson Modern

#13-120  
Blow Off Valves Crane Older Style

#13-174  
Starter Valve w/Piping

#13-155  
Valve Cam Box

#13-199  
Check Valves Vertical Right & Left

#13-198  
Check Valves Large Lagged Pipe

#13-200  
Check Valves Large Top Feed

#13-226  
Valves on Pipes 4pc. set

#13-272  
Valve Wheel 7/32" dia

## W WASH OUT PLUGS



#13-271  
Wash Out Plugs

## WATER SCOOP



#13-280  
Water Scoop  
for Tender  
Decks

## WATER HATCH



#13-180  
Water Hatch  
3 Lid Tender

## WHISTLES

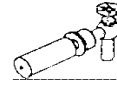

#13-276  
Whistle w/  
Valve



#13-148  
Straight

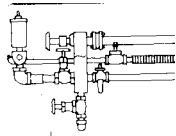

#13-261  
Saturated Steam

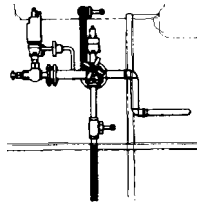

#13-140  
Saturated Steam

## WHISTLES

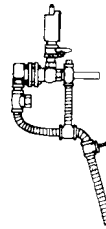

#13-201  
Saturated Steam



#13-149  
Whistle

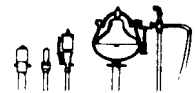

#13-164  
Whistle, Bell  
& Valve  
Small Loco Detail

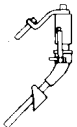

#13-202  
Smokebox  
Mount



#13-146  
Left Side  
Mount



#13-147  
Right Side  
Mount